



## USE OF CHAOTIC BEHAVIOUR IN COMMUNICATION SECURITY

Mutamed Khatib<sup>1</sup>

---

### ABSTRACT

*In this paper, the chaos signal results from some selected dynamical modes formed from a dc biased Josephson junction is used in amplitude modulation instead of the usually used carrier. This will result in a modulated signal that is not possible to be detected without using the same signal used in the transmitter.*

---

**Key Words:** Amplitude modulation, Communication security, Chaos, Josephson junction.

### INTRODUCTION

Since the research on chaos signals in Josephson junctions by (Cawthorne *et al.*, 1998) it has been clear that superconducting weak links may exhibit chaotic dynamical behavior.

Josephson junction is a superconducting device, which can be represented in different models such as, shunted linear resistive models (RSJ), shunted linear resistive-capacitive models (RCSJ), shunted nonlinear resistive-capacitive models and shunted nonlinear resistive-capacitive models (RCLSJ) (Cawthorne *et al.*, 1998). Resistive shunts (Figure 1) are required when superconductor-insulator-superconductor (SIS) Josephson junctions are used in many applications. Josephson junction array oscillators, some digital logic circuits, and superconducting quantum interference devices (SQUIDs), for example, all employ resistively shunted Josephson junctions. The spatial extent of a shunt resistor and its associated wiring inevitably results in a series inductive component. In fact, it has been shown that if the inductance is high enough, such a junction can exhibit chaotic behavior (Cawthorne *et al.*, 1998).

Because the relevant time scales of the dynamics of typical Josephson junctions are on the order of a few picoseconds, simulations must be used to explore junction dynamics. Typically, the resistively capacitive shunted junction model is used to simulate junctions (as shown in Figure 2), resulting in a fairly good agreement with experiment. Also, this model shows chaotic behavior

---

<sup>1</sup> Department of Telecommunication Engineering Palestine Technical University-Kadoorie (PTU-K), Palestine.

when driven by external sinusoidal signal. The RCSJ model, however, fails to reproduce significant features on experimental I-V curves when the shunt of the junction contains an inductive component. A more improved model of Josephson junction has been proposed by replacing the linear resistor by a voltage dependent one as: (Whan and Lobb, 1995)

$$R(v) = \begin{cases} R_n & \text{if } |V| > V_g \\ R_{sg} & \text{if } |V| \leq V_g \end{cases} \quad (1)$$

Better agreement is obtained when the RCSJ model is modified by including an inductor in series with the shunt resistor that is called RCLSJ. This model shows chaotic behavior when driven by external dc signal (Whan and Lobb, 1995).

Usually, power engineers study the chaotic behavior of the JJ in order to avoid reaching it because of its dangerous effects on the power stations. In this paper, we'll generate the chaos signals in order to use them in the communication systems.

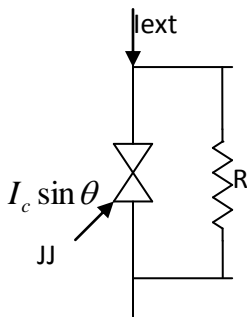

Figure-1. RSJ Model of JJ.

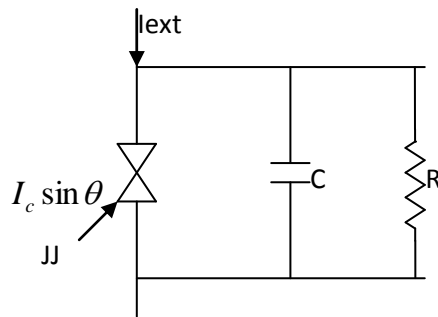
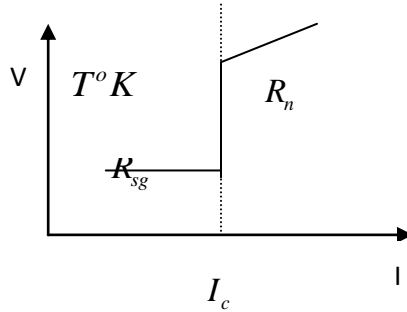

Figure-2. Linear RCSJ Model JJ.

### SYSTEM ANALYSIS

When an external current is applied across the superconducting junction, a voltage  $V$  develops across the junction. The current-voltage (I-V) characteristic of the junction in Figure 3 at a particular temperature  $T^o K$  shows hysteresis at a critical current  $I_{ext} = I_c$ , where  $R_n$  is the junction normal state resistance and  $R_{sg}$  is the sub gap resistance (Dana and Edoh, 2001).



**Figure-3.** I-V characteristics of the junction

The complex dynamics in JJ arises due to the hysteresis in the current-voltage characteristic. The external current is assumed to consist of both dc and ac components (Dana and Edoh, 2001).

$$I_{ext} = I_o + I_1 \sin(\omega t) \tag{2}$$

The circuit equations of the circuit in Figure 1 are obtained, using Kirchhoff's laws, as

$$C \cdot \frac{dV}{dt} + \frac{V}{R} + I_c \cdot \sin \theta = I_{ext} \tag{3a}$$

$$\frac{h}{2\pi e} \cdot \frac{d\theta}{dt} = V \tag{3b}$$

where: V is the voltage across the superconductor junctions.

h is Plank's constant.

e is the electronic charge.

$\theta$  is the phase difference of the superconducting order parameters across the junction.

C is the junction capacitance.

If the external driving force is purely dc ( $I_{ext} = I_o$ ), chaotic motion is ruled out. When combined,

(2), in dimensionless normalized form, is converted to

$$\frac{d^2\theta}{dt^2} + \beta \cdot \frac{d\theta}{dt} + \Omega_o^2 \cdot \sin \theta = A_o + A_1 \cdot \sin(\omega t) \tag{4}$$

where:

$$\beta = \frac{1}{RC}, \text{ damping factor}, \Omega_o = \sqrt{\left(\frac{2\pi e I_c}{h.C}\right)},$$

$$A_o = \frac{2\pi e I_o}{h.C}, A_1 = \frac{2\pi e I_1}{h.C}$$

The state space of this system is:

$$\begin{aligned} \dot{x}_1 &= x_2 \\ \dot{x}_2 &= -\beta \cdot x_2 - \Omega_o^2 \cdot \sin x_1 + A_o + A_1 \cdot \sin(\omega t) \end{aligned} \tag{5}$$

where:

$$\begin{aligned} x_1 &= \theta \\ x_2 &= \dot{x}_1 = \dot{\theta} \end{aligned}$$

### SYSTEM MODEL

The simplest form of amplitude modulation is the Double sideband suppressed carrier (AM-DSB-SC), which is a result of multiplying the message by a high frequency periodic carrier (usually sinusoidal wave). In the receiver, the received signal is multiplied again by the same carrier and inserted to a low-pass filter LPF in order to detect the transmitted wave. This kind of modulation in a public transmission scheme, where anyone can detect the transmitted message by using the appropriate carrier, by simply searching for it in the desired band.

**Figure-4.** Block diagram of the proposed system

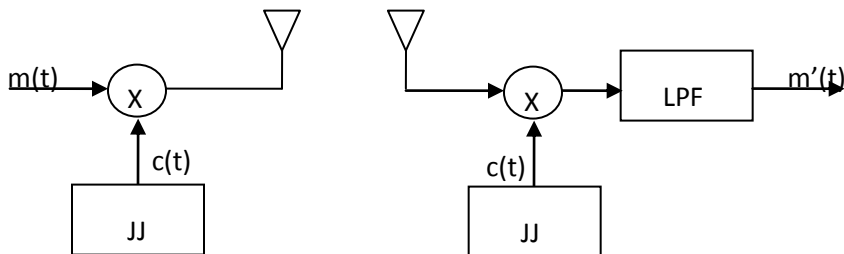

In this proposed system, the periodic carrier is replaced by a chaotic signal generated by the non-linear device using certain parameters known by the transmitter and the receiver only. Results shows that any slight change in the parameters will cause a significant change in chaos signal and the message will not be detected correctly.

### RESULT AND DISCUSSION

Figure 5 below shows the output of Josephson Junction for the values

$$(i_c = 0.8, \beta_c = 0.5, \omega = 0.66)$$

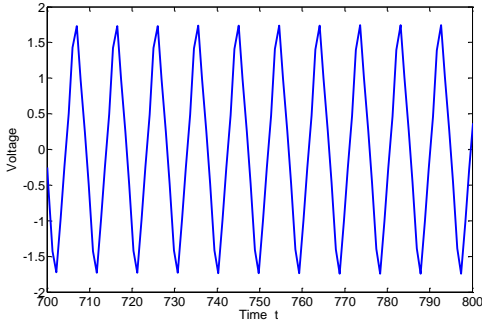

Figure-5. Time domain signal

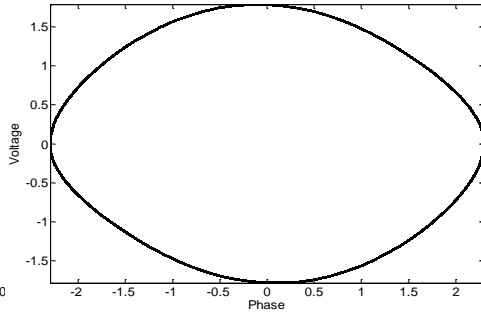

Figure-6. Phase diagram

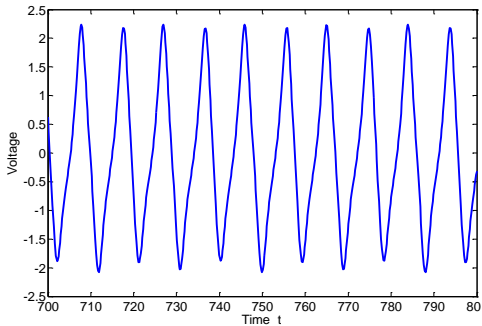

Figure-7. Time domain

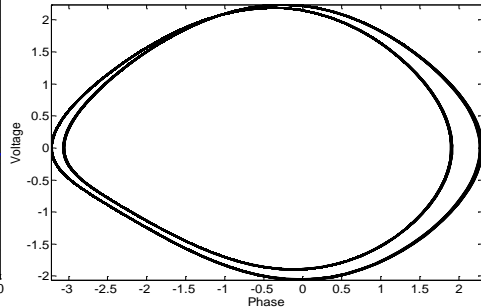

Figure-8. Phasor diagram

It can be easily noticed that the signal is periodic from the phasor diagram shown in Figure 6. Making a slight change in the variable ( $i_c = 1.0636, \beta_c = 0.5, \omega = 0.66$ ) results in a semi periodic as shown in Figure 7, Figure 8. Continuing the changes in the variable results in more complication in the output as shown in Figure 9 and Figure 10 for variables ( $i_c = 1.08, \beta_c = 0.5, \omega = 0.66$ )

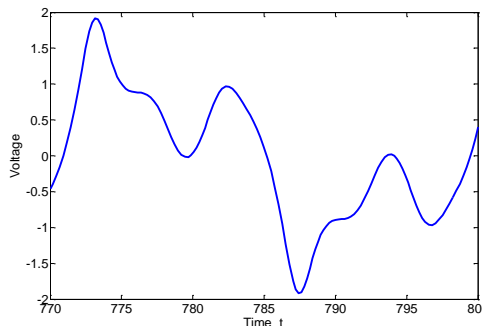

Figure-9. Chaos signal

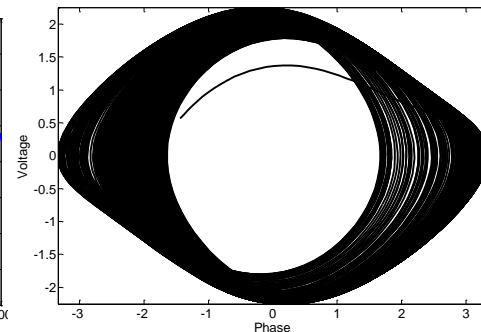

Figure-10. Phasor diagram

After this brief description about the Josephson output, a message signal is generated by adding two different frequencies as shown in Figure 11 for time domain and Figure 12 for the frequency domain

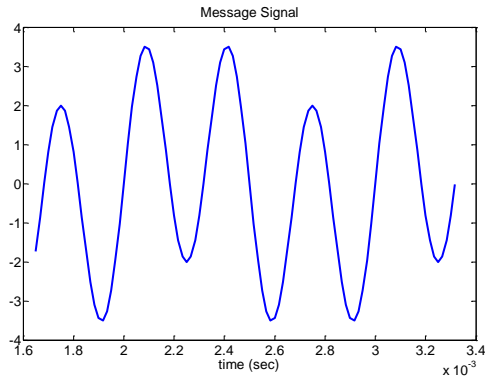

Figure-11. Time domain

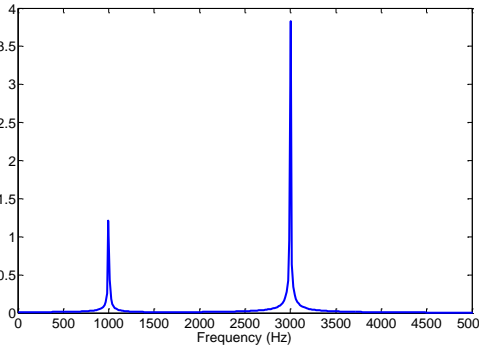

Figure-12. Frequency domain

Then a chaos signal is generated with wide frequency spectrum, then, the message is multiplied by the carrier, and the modulated signal is ready to be transmitted. In the receiver –assuming an ideal channel- the transmitted signal is received and multiplied again by the same carrier used in the transmitter in order to detect the message. Figure 13 shows that the message can be easily detected by using a filter. In Figure 14, a different chaos has been used, it is very clear that the signal is too noisy and not suitable for detection.

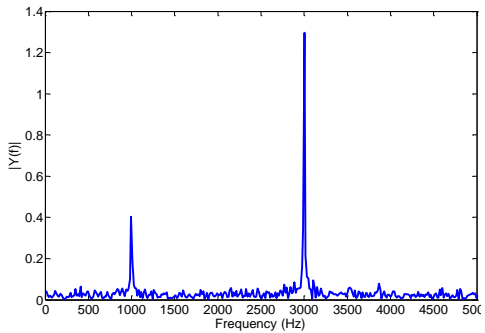

Figure-13. The same carrier

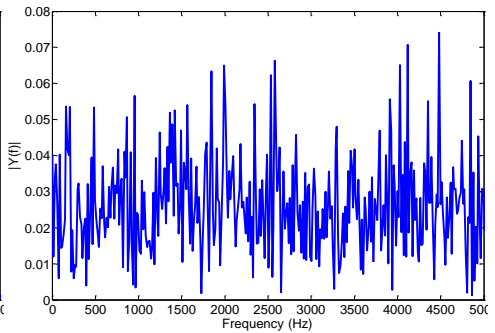

Figure-14. Different carrier

## CONCLUSION

Chaos signals can be used in communication systems as a carrier in order to obtain secure transmitted signal. This secure transmitted signal can be generated by multiplying the message by a high frequency chaos, and can be detected in the receiver by demodulating the received signal using the same chaos. Any other parameters used will cause a noisy detected signal.

## **ACKNOWLEDGEMENT**

The author would like to thank Palestine Technical University - Kadoorie for sponsoring this work.

## **REFERENCES**

- Cawthorne, A., C. Whan and C. Lobb, 1998. Complex dynamics of resistively and inductively shunted josephson junctions. *Journal of applied physics*, 84(2).
- Dana, S. and K. Edoth, 2001. Chaotic dynamics in josephson junction. *IEEE trans. On circuits and systems*, 48(8).
- Whan, C. and C. Lobb, 1995. Effect of inductance in externally shunted josephson tunnel junctions. *Journal of applied physics*, 77(1).

## **BIBLIOGRAPHY**

- Pedersen, N. and M. Cirillo, 1982. On bifurcations and transition to chaos in a josephson junction. *Physics Letters*, 90A(3).