

## Design and efficiency testing of a prototype extruder for Bang Kaew dog food production



**Thanwamas Phasinam**<sup>1</sup>

**Tossaporn Incharoen**<sup>2</sup>

**Chatchawin Nualsri**<sup>3</sup>

**Dowroong Watcharinrat**<sup>4</sup>

**Khongdet Phasinam**<sup>5\*</sup>

<sup>1</sup>*Agricultural Land Reform Office, Bangkok, Thailand.*

<sup>1</sup>*Email: [t.kassanuk@gmail.com](mailto:t.kassanuk@gmail.com)*

<sup>2</sup>*Faculty of Agriculture, Natural Resources and Environment, Naresuan University, Phitsanulok, Thailand.*

<sup>2</sup>*Email: [tossaporni@nu.ac.th](mailto:tossaporni@nu.ac.th)*

<sup>3</sup>*Faculty of Food and Agricultural Technology, Pibulsongkram Rajabhat University, Phitsanulok, Thailand.*

<sup>3</sup>*Email: [chatchawin.n@psru.ac.th](mailto:chatchawin.n@psru.ac.th)*

<sup>4</sup>*Email: [phasinam@psru.ac.th](mailto:phasinam@psru.ac.th)*

<sup>4</sup>*School of Liberal Art, Metharath University, Pathum Thani, Thailand.*

<sup>4</sup>*Email: [dowroong.w@mru.ac.th](mailto:dowroong.w@mru.ac.th)*



(+ Corresponding author)

### ABSTRACT

#### Article History

Received: 30 October 2023

Revised: 5 February 2024

Accepted: 22 February 2024

Published: 15 April 2024

#### Keywords

Agricultural machinery

Bang Kaew dog food

Cost-effective

Dog food production

Extruder machine

Local ingredients

Pet food industry

Production efficiency

Sustainable farming

Technological innovation.

This research aims to address this issue by designing and fabricating a prototype extruder specifically tailored for producing Bang Kaew dog food. The Bang Kaew dog breed, native to Thailand, poses a challenge for farmers seeking cost-effective dog food production using locally available ingredients. Despite attempts to minimize expenses, the necessity of machinery in pellet formation remains, contributing significantly to production costs. The study comprises two main phases: designing and fabricating the extruder machine and testing its efficiency for Bang Kaew dog food production. The extruder, a single screw machine, measures 380 x 810 x 345 millimeters and operates on 220 volts, consuming 2200 watts of power. After rigorous testing, the optimal extruder speed for Bang Kaew dog food production was found to be 400 rpm, achieving a production capacity of 136.29 kilograms per hour and a maximum efficiency of 74 percent. The produced dog food exhibited a moisture content of 9.01 percent and specific color values ( $L^*=72.18\pm 1.75$ ,  $a^*=2.60\pm 0.22$ ,  $b^*=14.35\pm 0.41$ ). Additionally, the hardness measured 272.82 Newton, and the water activity ( $a_w$ ) was 0.67. Significantly, the physical characteristics of the dog food produced at 400 rpm closely resembled those of commercial dog food. This study showcases the successful development of an efficient extruder machine tailored for Bang Kaew dog food, providing valuable insights for the pet food industry.

**Contribution/ Originality:** This study pioneers the development of a specialized extruder for Bang Kaew dog food production, addressing the unique challenges faced by farmers. The novel approach lies in the integration of locally available ingredients, offering a cost-effective solution that combines technological innovation with practicality, distinguishing it from existing research in the field.

### 1. INTRODUCTION

The Bang Kaew dog, native to Thailand's Phitsanulok province, captivates with its distinctive appearance, marked by long fur, bushy tails, and well-proportioned bodies [1]. Beyond their physical charm, the nation cherishes these dogs for their affectionate nature, deep loyalty, intelligence, and agility. Their spirited temperament

sets them apart, making them highly sought after across Thailand. Despite their popularity, raising Bang Kaew dogs poses challenges related to breeding practices, nutrition, disease prevention, and marketing [2].

To meet the unique needs of Bang Kaew dogs, innovative solutions are essential. Dog food production requires meticulous attention to nutritional balance to effectively meet the dietary needs of dogs at various life stages. Commonly, dog food comes in five distinct types: dry, semi-moist, wet, nutritional comparison studies, and the emerging category of vegetarian and vegan pet food [3]. While these types differ in composition, they share common raw materials like meat, grains, nuts, and plant proteins.

The manufacturing process varies based on the type of dog food. Dry food can be produced by mixing raw materials, using an expander or extruder machine, and applying heat and pressure. Alternatively, baking at high temperatures creates a palatable product without adding oil. Canned dog food involves grinding and cooking raw materials before carefully packing them into sealed cans. A sterilization process ensures the safety and quality of the final product [4].

This intricate process highlights the importance of precision and expertise in dog food production. The methods employed must not only meet the nutritional requirements of dogs, but also ensure the food's safety and palatability. These considerations are paramount in the creation of high-quality dog food, addressing the diverse needs of our canine companions.

The extruder stands out as a unique machine capable of amalgamating multiple production steps seamlessly, a process aptly termed extrusion cooking. Unlike other methods, this technology integrates mixing, heating, ripening, and forming the finished product within a single apparatus. At the core of the extruder lies a crucial component: a rotating screw enclosed within a double-walled steel casing, commonly known as the barrel. This screw serves a vital function; it propels materials inside the machine forward through an opening on the die head flange [5].

What makes extrusion cooking especially remarkable is its reliance on high temperatures and a brief cooking duration. This combination allows for the preservation of the food's nutritional value, a pivotal factor in the context of pet food production. Additionally, this process imparts a desirable texture to the food, rendering it both puffy and crispy, all without the need for traditional frying methods involving oil [6, 7]. In essence, extrusion cooking represents a cutting-edge approach that not only streamlines the production process by consolidating multiple stages into one machine but also ensures the final product's quality and palatability. Through the application of high temperatures within a controlled timeframe, extrusion technology has revolutionized pet food manufacturing, offering a means to create nutritionally rich, textured, and appealing pet food without the drawbacks associated with traditional frying techniques.

The above-described production process highlights a significance challenge for dog food manufacturers: the elevated production costs, primarily due to the sophisticated machinery and equipment required to create dog pellets [8].

The study reveals a scarcity of research on dog food production machinery, but there is ample investigation into animal feed production machinery. For instance, Sukmoonsiri, et al. [8] conducted a study titled "Development of an Animal Feed Pelleting Machine." Their research focused on fabricating and testing a prototype for this machine, consisting of four main parts: a steel frame, grinding unit, mixing unit, and pellet extruding unit. They set the motor set speeds at 1,100, 1,430, and 1,750 rpm, and used three formulated animal feeds. Performance parameters included processing capacity, percentage recovery, electrical consumption, and economic analysis. Optimal results were obtained at 1,750 rpm, with a machine recovery of 83 percent and an average processing capacity of 23 kilograms per hour. Economic analysis indicated an operation cost of 37.5 baths per hour, with a break-even point of 3,052 kilograms per year and a payback period of 2.2 years.

Another study by Sunmonu, et al. [9] focuses on the design and evaluation of a fish feed pelletizer featuring varying die-plate sizes. The pelletizer was tested with non-conventional feed resources, namely fermented citrus

and plantain peels. We evaluated performance indices such as pelleting efficiency, percentage recovery, and percentage of unpelleted feed. Statistical analysis revealed significant differences in performance indices based on die sizes. The study emphasizes the importance of die-plate variations for specific feed formulations, contributing to improved efficiency.

Muo, et al. [10] present a locally fabricated electrically powered fish feed pelleting machine, addressing the issue of high feed costs for fish farmers. The machine utilizes three electric gear motors and stainless steel components to minimize rust contamination. With a calculated pelleting efficiency of 97 percent, the machine is capable of producing 0.0539 kilograms of feed per second. This study highlights the importance of locally sourced materials and technology in developing cost-effective solutions for the aquaculture industry.

Okolie, et al. [11] focus on producing a cost-effective fish feed pelletizer for peasant farmers. The designed machine includes a hopper, screw conveyor, barrel, dies, drive system, and heater. Performance tests revealed a throughput capacity of 17 kilograms per hour, machine efficiency of 73.33 percent, and a pelletizing efficiency of 90.90 percent. The study underscores the significance of designing pelletizers that consider factors such as cost, ease of operation, serviceability, durability, and performance to benefit small-scale farmers.

Lastly, Shrinivasa, et al. [12] highlighted the study focusing on designing a portable compound cattle feed pelleting machine for farm-level production. Acknowledging the gap between demand and supply of compound feeds, the researchers developed a machine to address the needs of dairy farmers. The machine exhibited a pelleting efficiency of 91.40 percent with a throughput capacity of up to 55 kilograms per hour. The study emphasizes the potential of farm-level feed pellet production using locally available resources, reducing dependency on expensive commercial feed.

Recognizing the financial burden associated with these costs, Bang Kaew breeder farmers have endeavored to utilize locally available raw materials to mitigate expenses [13]. However, the core challenge lies in the necessity of utilizing machinery for shaping dog food pellets. We conceived a novel solution in response to this challenge.

The researcher proposed an innovative approach: developing a prototype extruder machine tailored specifically for Bang Kaew dog food production. This inventive solution aimed to address the cost-intensive nature of traditional production methods. By designing a specialized extruder, the intention was to optimize the production process, making it more economically viable. Moreover, this initiative had the potential to serve as a valuable guide for others interested in producing Bang Kaew dog food. In essence, this proactive approach represents a significant step towards sustainability and affordability in the production of dog food. By harnessing local resources and innovating the manufacturing process through specialized machinery, the project not only aimed to reduce costs but also set a precedent for a more accessible, community-driven approach to pet food production. This endeavor not only tackles financial constraints but also fosters a sense of self-sufficiency within the community, contributing to the overall welfare of Bang Kaew breeders and their cherished canine companions.

## 2. MATERIALS AND METHODS

### 2.1. Design and Fabrication of a Specialized Extruder for Bang Kaew Dog Food Production

In the pursuit of optimizing Bang Kaew dog food production, a pivotal step involved the meticulous design and fabrication of a specialized extruder. We meticulously crafted a detailed 3D model using advanced technology, particularly the Solid Works program. This virtual model allowed for a comprehensive understanding of the extruder's dimensions and components, ensuring precision and consistency throughout the fabrication process [14, 15].

**Design Specifications:** The extruder, configured as a single-screw system, was meticulously planned utilizing the Solid Works program [Figure 1](#). The resulting design boasted dimensions of 380 x 810 x 345 millimeters, featuring stainless steel barrels in a double-layered arrangement. The inner barrel measured 3 centimeters in diameter and 9 centimeters in length, while the outer barrel had a diameter of 4.7 centimeters and a similar length.

Crucially, the ingenious segmentation of the 2.5 centimeter diameter compression screw into two distinct pitch periods was crucial. In period 1, the pitch distance equaled 0.44 centimeters, transitioning to 1.45 centimeters in period 2 [Figure 2](#).

**Power Source:** we used robust current electric motor operating at 220 volts and 2200 watts to drive this intricate extruder. Power transmission to the compression screw was achieved through a meticulously engineered belt system, ensuring efficient and reliable operation.

**Significance:** This meticulously designed extruder represents a fusion of innovative engineering and advanced modeling techniques. By employing the Solid Works program, a highly accurate 3D representation was crafted, providing insights into both the structure and function of the extruder. This meticulous planning and precise fabrication process not only ensure the consistent production of Bang Kaew dog food but also serve as a beacon of efficiency, guiding future endeavors in the realm of specialized pet food production.

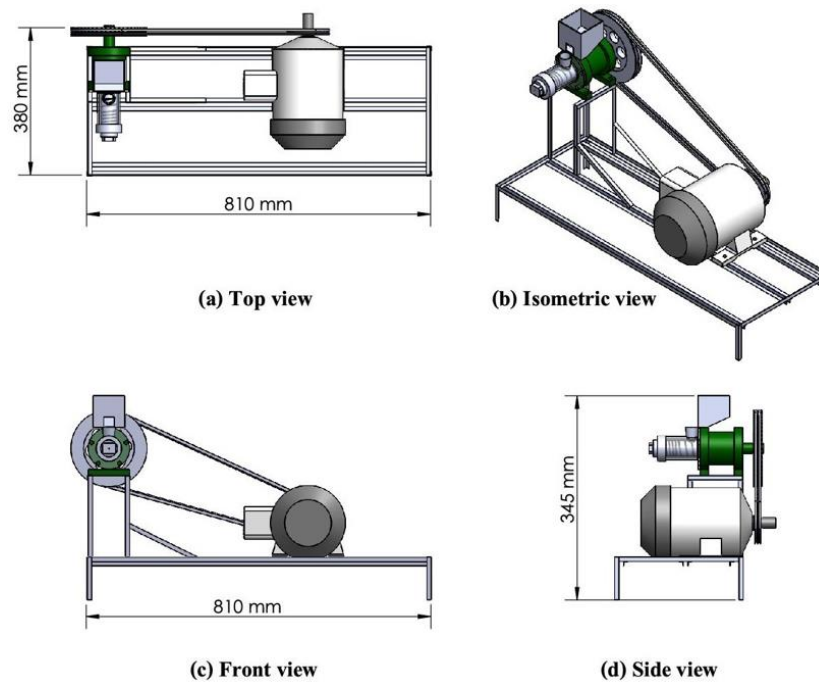

**Figure 1.** 3D model of a prototype extruder for Bang Kaew dog food production.

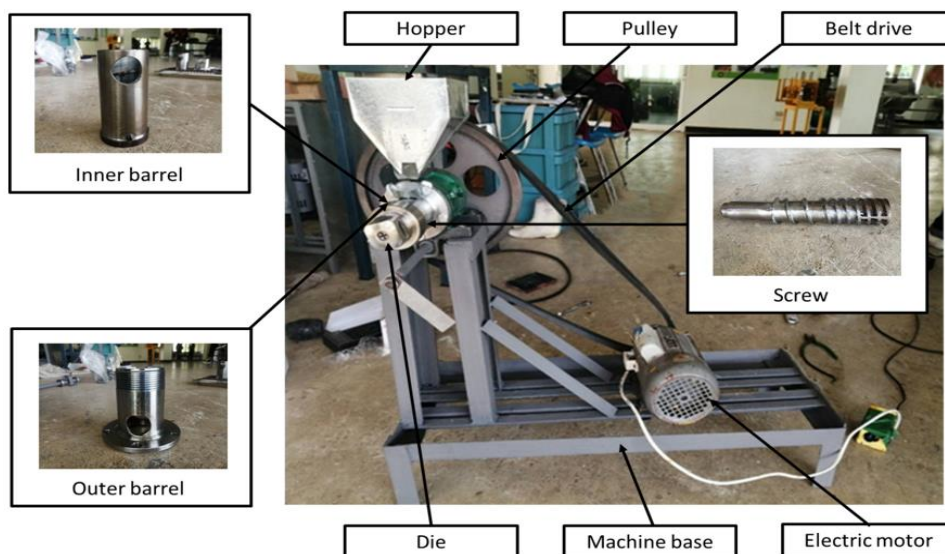

**Figure 2.** Components of a prototype extruder for Bang Kaew dog food production.

## 2.2. Testing the Efficiency and Operation of the Extruder

A rigorous series of tests, systematically designed to assess the extruder's performance at varying speeds: 300, 350, and 400 rpm, carried out the evaluation of its efficiency. The testing process involved several meticulous steps to ensure a comprehensive analysis.

1) Preparation of Dog Food Ingredients: The first step involved the meticulous preparation of dog food ingredients, including 2 cups of all-purpose flour, 1 cup of rice, 2 cups of boiled vegetables, 1 cup of cooked liver, and 1 teaspoon each of yeast powder, sugar, and salt [16].

2) Mixing and Weighing: The prepared ingredients were thoroughly mixed and carefully weighed to maintain precision and consistency in the test samples.

3) Extrusion Process: The mixed dog food was fed into the extruder machine, with the extruder operating at speeds of 300 rpm (T1), 350 rpm (T2), and 400 rpm (T3). During this process, the timer was activated to monitor the duration, ensuring accurate timing for each extrusion.

4) Weighing and Drying: We meticulously weighed the extruded dog food to quantify the output. Subsequently, the extruded product underwent a drying process in a hot air oven at precisely 80 degrees Celsius for 10 minutes [17, 18].

5) Physicochemical Quality Testing: To comprehensively assess the quality of the extruded dog food, a detailed physicochemical analysis was conducted. The samples were divided into six groups, each comprising three replicates of 20 uniformly sized food pellets. Using a completely randomized design (CRD), consistent food pellet selections were made for each group. The quality assessment involved crucial parameters. First, the moisture content was determined using Association of Official Analytical Chemists (AOAC) methods [19]. Second, the color ( $L^*a^*b^*$  color space) of Bang Kaew dog food samples was measured using a color meter (Konica Minolta, Model CR-10, Japan) (Figure 3). Third, the water activity was analyzed with a water activity meter (Decagon Devices, Inc., Aqualab 4TE, USA) (Figure 4). Fourth, the assessment of Bang Kaew dog food sample hardness was conducted through instrumental evaluation utilizing a texture analyzer (Model TA-XT plus, Stable Micro Systems, UK) accompanied by the exponent software (Figure 5). The back extrusion procedure, as outlined by Makroo, et al. [20], with certain adaptations [21-23], was employed for this evaluation. Subsequently, statistical analysis of the acquired data was carried out using analysis of variance (ANOVA) through the SPSS program. We performed meticulous comparisons using Duncan's method to determine significant differences among the evaluated parameters.

Test Details:

T1 (300 rpm): Extruded dog food at a speed of 300 rpm.

T2 (350 rpm): Extruded dog food at a speed of 350 rpm.

T3 (400 rpm): Extruded dog food at a speed of 400 rpm.

T4 (Dog Food Brand A): Commercial dog food brand A.

T5 (Dog Food Brand B): Commercial dog food brand B.

T6 (Dog Food Brand C): Commercial dog food brand C.

This thorough testing methodology, encompassing a spectrum of parameters and speeds, ensured a nuanced understanding of the extruder's efficiency and provided valuable insights into its performance compared to established commercial dog food brands. The application of statistical analyses further validated the results, making this evaluation a robust and reliable assessment of the extruder's capabilities.

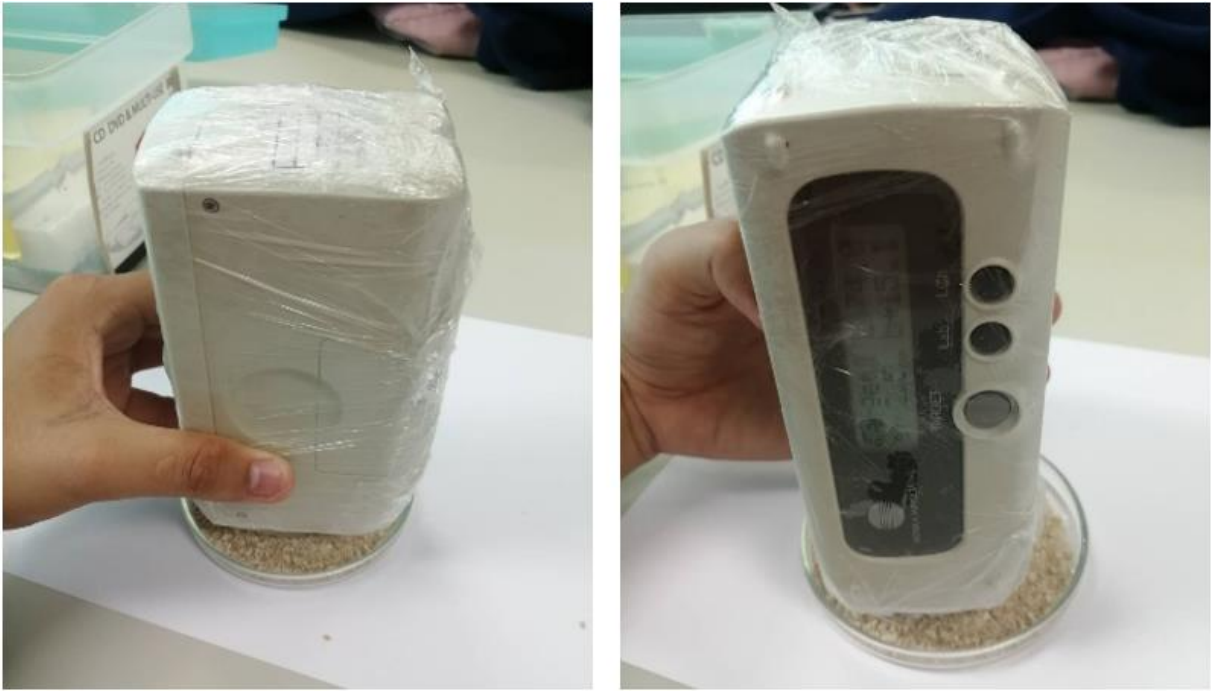

Figure 3. Testing for the color of Bang Kaew dog food.



Figure 4. Testing for the water activity of Bang Kaew dog food.

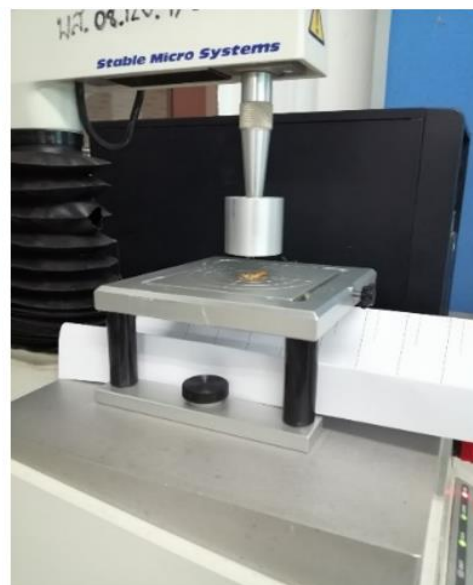
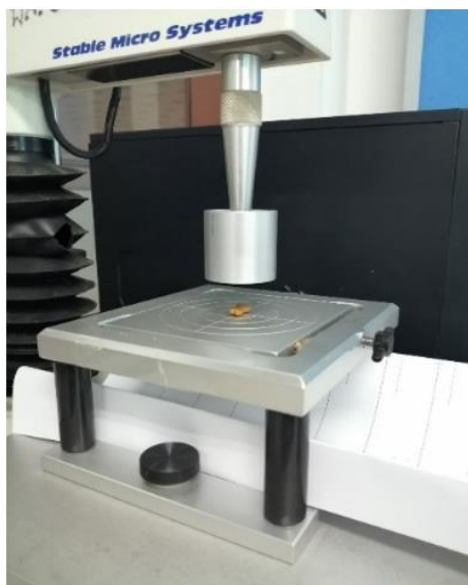

Figure 5. Testing for the hardness of Bang Kaew dog food.

### 3. RESULTS AND DISCUSSION

Following rigorous testing of a single-screw extruder tailored for Bang Kaew dog food production, powered by a single-phase alternating current (AC) electric motor rated at 220 volts and 2200 watts, detailed evaluations were conducted at rotational speeds of 300, 350, and 400 rpm. The outcomes revealed the extruder's production capacities at these speeds, quantified as 177.58 kilograms per hour, 196.85 kilograms per hour, and 136.29 kilograms per hour, respectively. Additionally, the efficiency of dog food production at these speeds stood at 71 percent, 74 percent, and 74 percent, respectively, emphasizing the extruder's consistent performance across different rotational velocities (Figure 6). These findings not only showcase the extruder's output capabilities but also underscore its efficiency, with the 74% efficiency at 350 and 400 rpm indicating a noteworthy achievement in optimizing Bang Kaew dog food production.

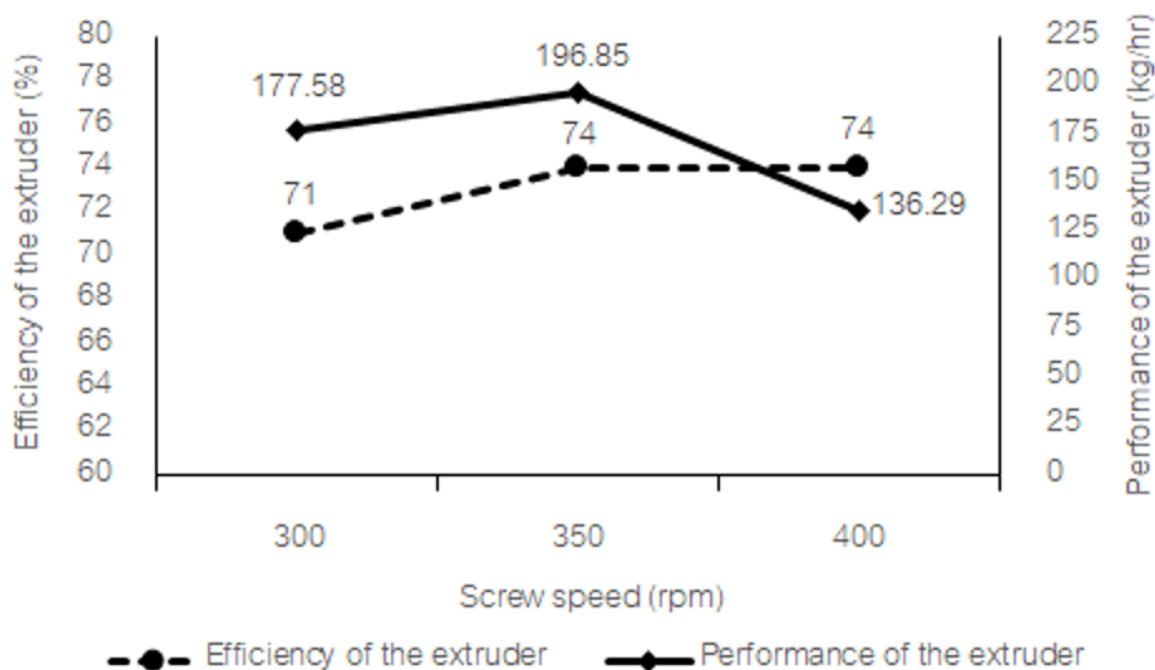

Figure 6. Evaluation of extruder machine effectiveness in dog food production.

Table 1. Characteristics of dog food.

Treatment	Moisture content (%)	Water activity	Color			Hardness (N)
			L*	a*	b*	
T1	12.65 <sup>a</sup> ± 4.81	0.68 <sup>a</sup> ± 0.0047	71.40 <sup>a</sup> ± 1.05	4.23 <sup>c</sup> ± 1.02	12.60 <sup>d</sup> ± 0.34	375.09 <sup>a</sup> ± 68.05
T2	10.29 <sup>ab</sup> ± 2.52	0.67 <sup>a</sup> ± 0.0013	73.00 <sup>a</sup> ± 2.62	2.79 <sup>d</sup> ± 2.59	12.98 <sup>d</sup> ± 0.52	292.18 <sup>b</sup> ± 118.94
T3	9.01 <sup>bc</sup> ± 3.56	0.67 <sup>b</sup> ± 0.0019	72.18 <sup>a</sup> ± 1.75	2.60 <sup>d</sup> ± 0.22	14.35 <sup>c</sup> ± 0.41	272.82 <sup>b</sup> ± 75.66
T4	9.11 <sup>bc</sup> ± 0.97	0.53 <sup>d</sup> ± 0.0098	54.39 <sup>b</sup> ± 1.59	6.40 <sup>b</sup> ± 0.27	20.57 <sup>b</sup> ± 1.38	237.91 <sup>bc</sup> ± 19.08
T5	7.39 <sup>c</sup> ± 1.45	0.54 <sup>c</sup> ± 0.0025	51.63 <sup>c</sup> ± 2.00	6.24 <sup>b</sup> ± 0.91	19.76 <sup>b</sup> ± 2.04	247.00 <sup>bc</sup> ± 24.00
T6	8.14 <sup>bc</sup> ± 0.76	0.50 <sup>e</sup> ± 0.0020	55.23 <sup>b</sup> ± 1.85	8.48 <sup>a</sup> ± 0.68	24.02 <sup>a</sup> ± 1.76	203.03 <sup>c</sup> ± 29.89

Note: The notation a, b, c, d, e accompanying means and standard deviation (± S. D.) values in the same column signifies statistical significance differences among the groups or conditions being compared. These letters are used as post hoc indicators to denote groups that differ significantly from each other. Each unique letter represents a distinct group or condition, and the presence of different letters indicates statistical significance at the predetermined level (p < 0.05). In this context, if two groups share the same letter, they are not considered significantly different, whereas different letters imply statistically significant distinctions between the corresponding groups; the letters L\*, a\*, and b\* represent each of the three values the CIELAB color space uses to measure objective color and calculate color differences.

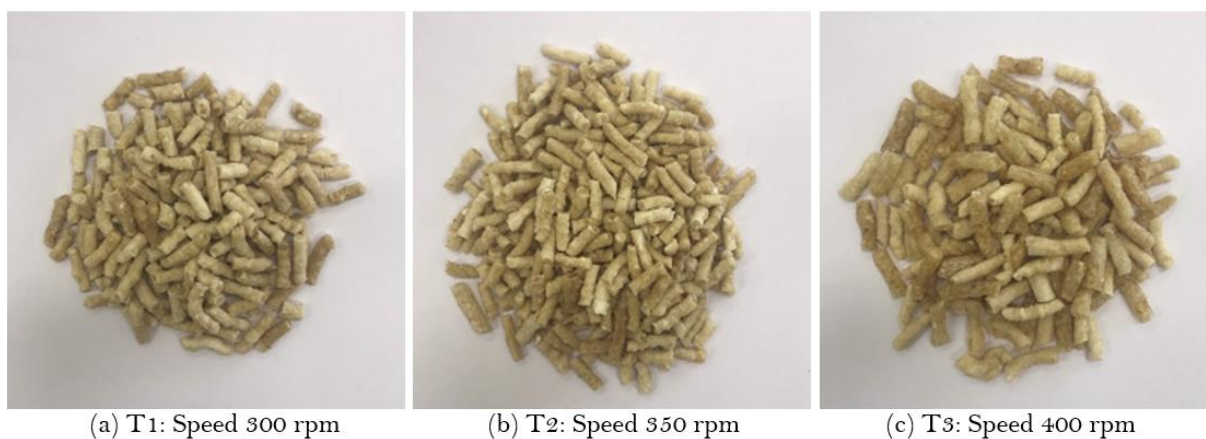

Figure 7. Appearances of the Bang Kaew dog food.

Analyzing the data presented in Table 1 and Figure 7, detailing the physical characteristics of dog food, a significant difference in moisture content was observed within the dog food samples produced using the prototype extruders (T1, T2, and T3). We conducted rigorous testing at a 95 percent confidence level and found a statistically significant difference in the moisture values of dog food extruded at varying speeds using the prototype extruder (T1, T2, and T3). Specifically, T3 exhibited the lowest moisture content at 9.01 percent, followed by T2 at 10.29 percent, and T1 at 12.65 percent. Comparatively, commercial dog food samples (T4, T5, and T6) demonstrated moisture content percentages of 9.11, 7.39, and 8.14, respectively. Remarkably, the moisture content of dog food produced at T3 closely resembled that of the majority of commercially available dog food. It is noteworthy that dry dog food typically adheres to a standard of no more than 10 percent moisture. Additionally, pet food with a moisture content ranging from 8-9 percent tends to exhibit a dry and crunchy texture, aligning with the desirable characteristics of high-quality dry pet food as outlined in scientific literature [24-26].

The water activity measurements of dog food produced using the prototype extruder were notably consistent, with values of 0.68 and 0.67 recorded for T1 and T2, respectively, indicating no significant differences between these samples. Similarly, T3 displayed a water activity of 0.68 and 0.67, showcasing remarkable stability and uniformity, especially when compared to T1 and T2. In contrast, commercial dog foods (T4, T5, and T6) exhibited distinct variations in water activity levels, registering at 0.53, 0.54, and 0.50, respectively. These values, lower than the samples from the prototype extruder, are crucial for ensuring the longevity of pet food products. This low water activity is a key factor contributing to the extended shelf life of dry pet foods, as it inhibits the growth of microorganisms, aligning with established research findings [26-29]. Specifically, studies such as Pongsawatmanit and Wuttijumnong [30] have indicated that a water activity level below 0.9 restricts the growth of almost all bacteria, and when the water activity drops below 0.7, most fungi are also unable to proliferate. These findings underscore the importance of maintaining low water activity levels in pet foods to ensure their safety and longevity on the market.

The color analysis of the dog food samples provided intriguing insights. In the case of the prototype extruders (T1, T2, and T3), the lightness ( $L^*$ ) values were measured at 71.40, 73.00, and 72.18, respectively. The red/green ( $a^*$ ) values for these samples stood at 4.23, 2.79, and 2.60, while the yellow/blue ( $b^*$ ) values were recorded as 12.60, 12.98, and 14.35. Conversely, commercial dog foods (T4, T5, and T6) exhibited different color profiles. The lightness ( $L^*$ ) values for these products were 54.39, 51.63, and 55.23, accompanied by red/green ( $a^*$ ) values of 6.40, 6.24, and 8.48, and yellow/blue ( $b^*$ ) values of 20.57, 19.76, and 24.02, respectively. These color variations are indicative of the raw ingredients utilized in the production process. Notably, the specific ingredients employed directly link to the yellow/blue appearance and red/green tones in the dog food samples. This color analysis is crucial not only for understanding the visual appeal of the dog food but also for discerning the quality and composition of the ingredients, thereby offering valuable insights into the production process and the potential



preferences of consumers and their pets.

The prototype extruder's application of pressure to break the product yielded insightful results when evaluating the texture and hardness of the dog kibble. Specifically, for the prototype extruders (T1, T2, and T3) the required pressure stood at 375.09, 292.18, and 272.82 newtons, respectively. In comparison, commercial dog food products (T4, T5, and T6) demonstrated varying resistance levels, with breakage pressures measuring 237.91, 247.00, and 203.03 newtons, respectively. These findings emphasize that the hardness of the dog food produced using the extruder, especially the T3 prototype, closely mirrors that of commercial pellets available on the market. This similarity in texture suggests that the extruder's output, particularly in this specific setting, aligns with the established industry standards, ensuring that the produced dog kibble possesses the desired level of firmness and resistance, crucial factors influencing pet palatability and satisfaction. These results underscore the extruder's capability to produce dog food with consistent and desirable textural attributes, meeting the expectations of both manufacturers and consumers.

#### 4. CONCLUSION

The single-screw extruder designed specifically for Bang Kaew dog food production boasts precise dimensions of 380 x 810 x 345 millimeters, featuring a stainless steel barrel with a diameter of 30 millimeters and a length of 90 millimeters. The compression screw, pivotal to the extrusion process, measures 25 millimeters in diameter with a thread pitch of 5 millimeters. A single-phase AC electric motor with a rating of 220 volts and 2300 watts powers this innovative apparatus. The extruder operates optimally at a speed of 400 rpm, exhibiting an impressive production capacity of 136.29 kilograms per hour, coupled with an outstanding efficiency rate of 74 percent. Upon testing, the resulting Bang Kaew dog food showed remarkable qualities. It displayed a moisture content of 9.01 percent, indicating an optimal balance between moisture and texture. Its color parameters were measured, yielding a lightness ( $L^*$ ) value of  $72.18 \pm 1.75$ , a red/green ( $a^*$ ) value of  $2.60 \pm 0.22$ , and a yellow/blue ( $b^*$ ) value of  $14.35 \pm 0.41$ , underscoring its visual appeal. Furthermore, we measured the dog food's hardness at 272.82 Newton, indicating desirable texture for consumption. Its water activity ( $a_w$ ) stood at 0.67, affirming its stability. Most notably, the physical characteristics of the dog food produced at 400 rpm closely mirrored commercial dog food available on the market, attesting to the extruder's ability to create products of industry-standard quality. This comprehensive evaluation underscores the extruder's precision, efficiency, and the exceptional quality of Bang Kaew dog food it produces.

**Funding:** This research is supported by the Pibulsongkram Rajabhat University, Thailand (Grant number: RDI-2-63-35).

**Institutional Review Board Statement:** Not applicable.

**Transparency:** The authors state that the manuscript is honest, truthful, and transparent, that no key aspects of the investigation have been omitted, and that any differences from the study as planned have been clarified. This study followed all writing ethics.

**Competing Interests:** The authors declare that they have no competing interests.

**Authors' Contributions:** All authors contributed equally to the conception and design of the study. All authors have read and agreed to the published version of the manuscript.

#### REFERENCES

- [1] R. Angkura, P. Karndee, and T. Chaengkasemsuk, "Development guidelines for Thai Spitz, Thai Bang Kaew dog to be a new international recognized breed of dog: A social science dimension study," *Electronic Journal of Open and Distance Innovative Learning*, vol. 5, no. 2, pp. 16–32, 2015.
- [2] W. Thonnondaeng *et al.*, "Factors limiting to Bang Kaew dog production in Phitsanulok province," *Khon Kaen Agriculture Journal*, vol. 47, no. Suppl. 1, pp. 1037-1044, 2019.

- [3] P. E. Watson, D. G. Thomas, E. N. Bermingham, N. M. Schreurs, and M. E. Parker, "Drivers of palatability for cats and dogs—what it means for pet food development," *Animals*, vol. 13, no. 7, p. 1134, 2023. <https://doi.org/10.3390/ani13071134>
- [4] V. Panichpol, V. Wanasitchaiwat, W. Jeimjetcharoon, and C. Khemsawat, "Study on dry dog food production," Annual Research Report, Department of Livestock Development, Ministry of Agriculture and Cooperatives, 2005.
- [5] S. Charoenporn, "Reformed rice using extrusion," Thesis Master Degree of Science, Suranaree University of Technology, 2021.
- [6] L. Yu, H. S. Ramaswamy, and J. Boye, "Protein rich extruded products prepared from soy protein isolate-corn flour blends," *LWT-Food Science and Technology*, vol. 50, no. 1, pp. 279-289, 2013. <https://doi.org/10.1016/j.lwt.2012.05.012>
- [7] S. Sriwilai, P. Chalermchaiwat, N. Siriwong, and P. Chantaro, "The influence of barrel temperature and feed moisture on chemical, physical and sensory quality of high protein extrudates from Khao Dawk Mali 105 Brown Rice Flour," *King Mongkut's Agricultural Journal*, vol. 36, no. 3, pp. 158-167, 2018.
- [8] E. Sukmoonsiri, R. Kalsirisilp, and J. Langapin, "Development of animal feed pellet production machines," *Srinakharinwirot University Engineering Journal*, vol. 16, no. 3, pp. 62-74, 2021.
- [9] M. O. Sunmonu, M. M. Odewole, and K. J. Falua, "Design of a varying die-plate fish feed pelletizer and performance evaluation using a non-conventional feed sources," *Applied Science and Engineering Progress*, vol. 11, no. 4, pp. 263-271, 2018. <http://dx.doi.org/10.14416/j.ijast.2018.10.001>
- [10] V. I. Muo, B. Okpe, V. Okoloekwe, and C. C. Ogbu, "A design and fabrication of fish feed pelleting machine," *International Journal of Scientific Research and Management*, vol. 6, no. 7, pp. 78-84, 2016. <https://doi.org/10.18535/ijstrm/v6i9.ec01>
- [11] P. C. Okolie, I. C. Chukwujike, J. L. Chukwunke, and J. E. Dara, "Design and production of a fish feed pelletizing machine," *Heliyon*, vol. 5, no. 6, p. e02001, 2019. <https://doi.org/10.1016/j.heliyon.2019.e02001>
- [12] D. Shrinivasa, S. M. Mathur, and A. Khadatkar, "Design and evaluation of portable compound cattle feed pelleting machine for farm-level feed production," *Journal of Scientific and Industrial Research*, vol. 80, no. 2, pp. 105-114, 2021. <https://doi.org/10.56042/jsir.v80i02.41178>
- [13] S. Naichaona, P. Yooyaeam, P. Jaipong, S. Yaemkong, N. N. Tuan, and P. Kotham, "Costs and returns of breeding Thai Bangkaew dog farm in Phitsanuloke Province," *Khon Kaen Agriculture Journal*, vol. 47, no. Suppl. 1, pp. 903-908, 2019.
- [14] T. Kassaruk and K. Phasinam, "Design and construction of water hyacinth chopper," *RMUTI Journal Science and Technology*, vol. 13, no. 3, pp. 57-68, 2020.
- [15] K. Promjeen, T. Phasinam, and K. Phasinam, "Optimizing confectionery production: A semi-automatic gummy jelly dropping machine design and performance evaluation," *Edelweiss Applied Science and Technology*, vol. 8, no. 1, pp. 1-12, 2024. <https://doi.org/10.55214/25768484.v8i1.411>
- [16] S. Sukhonthasing, "Homemade dog and cat food," Retrieved: <https://www3.rdi.ku.ac.th/?p=45991>. 2021.
- [17] W. Hutakoovit, B. Soiraya, C. Phuenpipob, and D. Tungsatitporn, "Development model of breakfast cereal products which produce from banana flour by extrusion technology, Rajamangala University of Technology Phra Nakhon," Retrieved: [https://doi.nrct.go.th/ListDoi/listDetail?Resolve\\_Doi=10.14457/RMUTP.res.2010.1](https://doi.nrct.go.th/ListDoi/listDetail?Resolve_Doi=10.14457/RMUTP.res.2010.1). 2010.
- [18] N. Kunna, S. Thongkorn, P. Nonprasat, and P. Phugsin, "Development of high fiber cereal bar product from sinlek brown rice," *Dusit Thani College Journal*, vol. 15, no. 1, pp. 268-285, 2021.
- [19] AOAC, *Official methods of analysis*, 17th ed. Virginia, USA: The Association of Official Analytical Chemists, 2000.
- [20] H. Makroo, P. K. Prabhakar, N. Rastogi, and B. Srivastava, "Characterization of mango puree based on total soluble solids and acid content: Effect on physico-chemical, rheological, thermal and ohmic heating behavior," *Lebensmittel-Wissenschaft & Technologie*, vol. 103, pp. 316-324, 2019. <https://doi.org/10.1016/j.lwt.2019.01.003>
- [21] C. Panyayong and K. Srikaeo, "Pureed banana inflorescences and their potential uses in dysphagia diets," *Journal of Food Technology Research*, vol. 10, no. 1, pp. 25-36, 2023. <https://doi.org/10.18488/jftr.v10i1.3333>

- [22] K. Kaewsoorn *et al.*, "Evaluation of precision and sensitivity of back extrusion test for measuring textural qualities of cooked germinated brown rice in production process," *Foods*, vol. 12, no. 16, p. 3090, 2023. <https://doi.org/10.3390/foods12163090>
- [23] S. Parnsakhorn, J. Langkapin, P. Pansri, and T. Chaiyadam, "Effects of sterilization heating on the physical and chemical properties of rice wrapped in lotus leaf products in retort pouch packaging.," *Journal of Applied Research on Science and Technology*, vol. 19, no. 1, pp. 1-15, 2020.
- [24] I. Alexander, "You ask, we answer: Royal canin dog food," Retrieved: <https://petsmagnet.co.uk/blogs/news/you-ask-we-answer-royal-canin-dog-food>. 2022.
- [25] S. W. Crane, R. W. Griffin, and P. R. Messent, *Introduction to commercial pet foods. In Small Animal Clinical Nutrition; Hand, M.S., Thatcher, C.D., Remillard, R.L., Roudebush, P., Eds*, 4th ed. Topeka, KS, USA: Mark Morris Institute, 2000.
- [26] S. S. Samant, P. G. Crandall, S. E. Jarma Arroyo, and H.-S. Seo, "Dry pet food flavor enhancers and their impact on palatability: A review," *Foods*, vol. 10, no. 11, p. 2599, 2021. <https://doi.org/10.3390/foods10112599>
- [27] C. Lohse, "Preferences of dogs for various meats," *Journal of the American Animal Hospital Association*, vol. 10, pp. 187–192, 1974.
- [28] R. A. Alegría-Morán, S. A. Guzmán-Pino, J. I. Egaña, V. Sotomayor, and J. Figueroa, "Food preferences in cats: Effect of dietary composition and intrinsic variables on diet selection," *Animals*, vol. 9, no. 6, p. 372, 2019. <https://doi.org/10.3390/ani9060372>
- [29] Ö. Başer and S. Yalcin, "Determination of some quality characteristics in pet foods," *Ankara Üniversitesi Veteriner Fakültesi Dergisi*, vol. 64, no. 1, pp. 21-24, 2017. [https://doi.org/10.1501/vetfak\\_00000002768](https://doi.org/10.1501/vetfak_00000002768)
- [30] R. Pongsawatmanit and P. Wuttijumnong, "Evaluation of shelf life of food products," presented at the Documents for Seminars and Academic Training in the Food Industry, 2002.

*Views and opinions expressed in this article are the views and opinions of the author(s), Journal of Asian Scientific Research shall not be responsible or answerable for any loss, damage or liability etc. caused in relation to/arising out of the use of the content.*